



SAH
Stahlwerk Annahütte

SAS Bewehrungssystem Gewindestahl - Muffe

SAS Reinforcingsystem thread bar - coupler

SAS SYSTEMS



Vorteile Bewehrungssystem Gewindestahl - Muffe

advantages of reinforcing thread bar coupling system

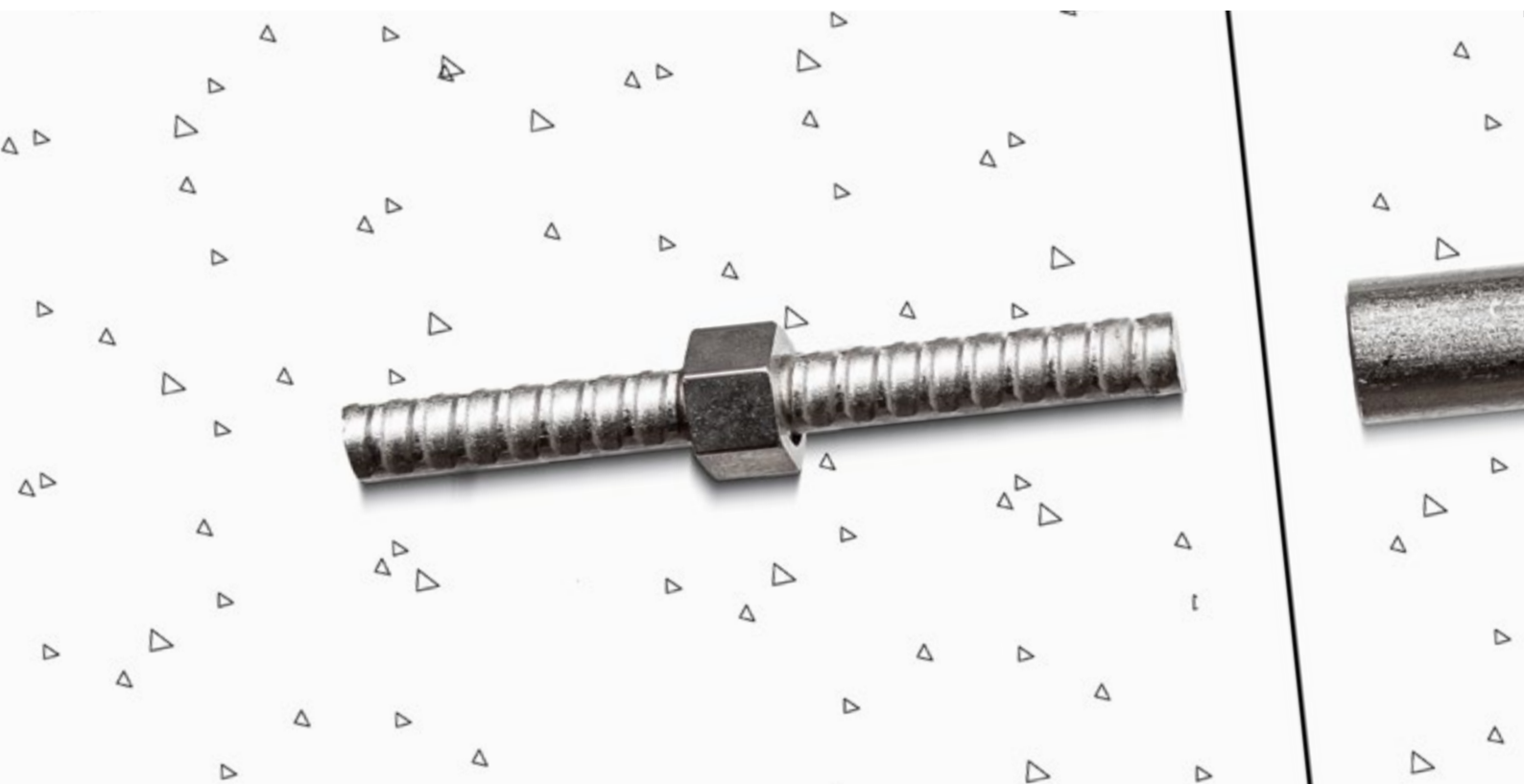

- ✓ Muffe und Stab in höchster Qualität aufeinander abgestimmt
- ✓ Endlos schraubbares, robustes und baustellen-gerechtes Grobgewinde
- ✓ Vollstoß (100%) in einer Ebene zulässig
- ✓ Stahllängen werden individuell zugeschnitten und gebogen
- ✓ Sonderausführungen möglich (z.B. Verzinken von Stahl und Zubehör)
- ✓ Zulassungen in diversen Europäischen Ländern für Stabdurchmesser 12 mm bis 50 mm verfügbar
- ✓ Zugelassen für außergewöhnliche Lastfälle wie z.B. zur Verwendung in Kernkraftwerken
- ✓ Umwandlung aller Systeme in SAS 500 möglich
- ✓ Einfache Handhabung und günstig
- ✓ *thread bars and coupler coordinated in highest quality*
- ✓ *screwable thread ribs along full length of the bar, robust, site-proven self-cleaning thread*
- ✓ *mechanical thread bar splicing allow 100 % in one section*
- ✓ *individual customized bar lengths available*
- ✓ *hot-dip galvanized bars as well as accessories are available*
- ✓ *approvals for thread bar diameter 12 - 50 mm available in several European countries*
- ✓ *approved for extreme load cases e.g. like the using in nuclear power plants*
- ✓ *SAS 500 reinforcing thread bar coupling systems replaces many other bar connection systems*
- ✓ *easy handling and cost effective*

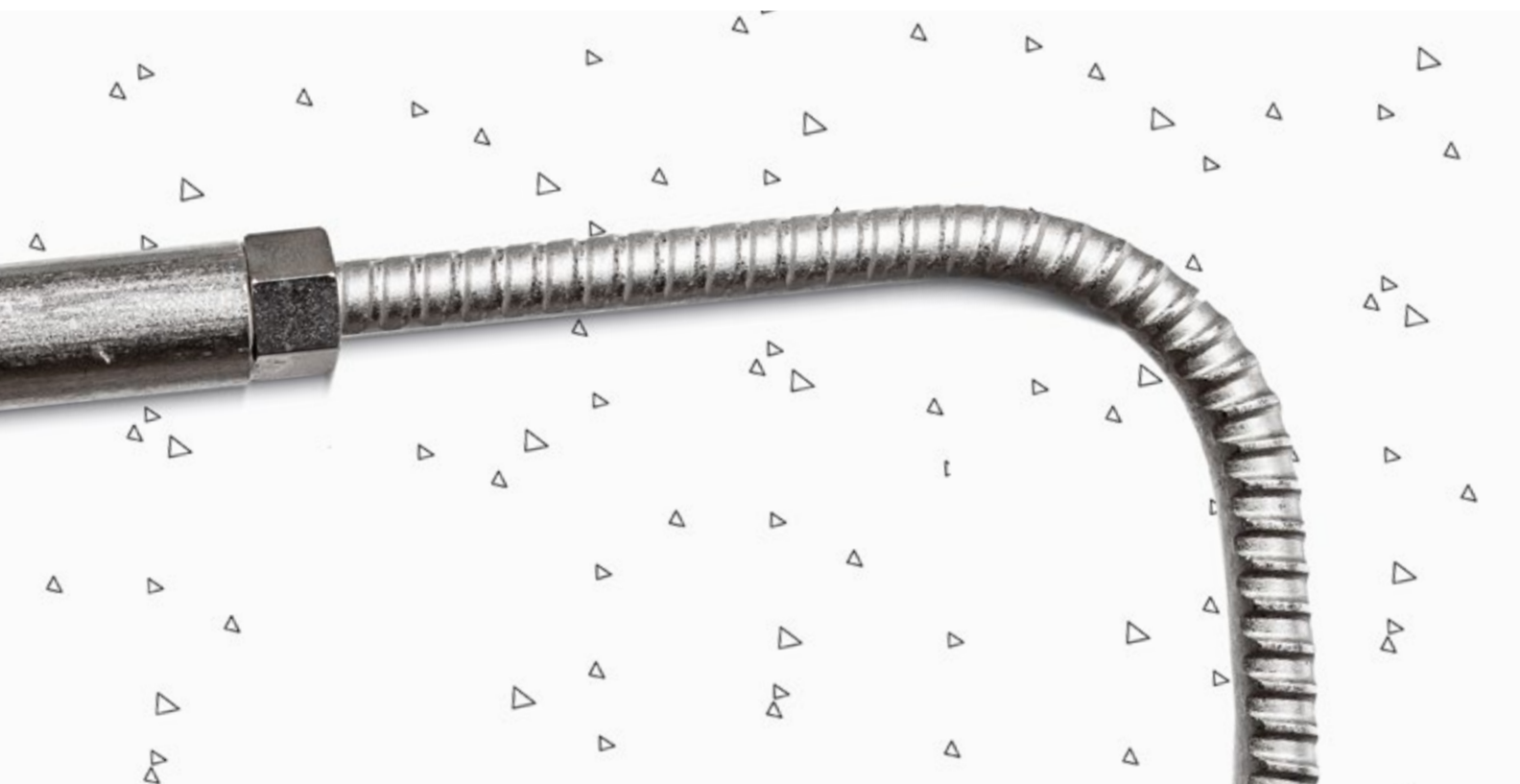

Vorteile gegenüber Feingewinde:

- ✓ unempfindliches Grobgewinde, kann nicht beschädigt werden.
- ✓ Selbstreinigungseffekt
- ✓ Kürzen und Verlängern des Gewindestahls problemlos möglich
- ✓ keine teuren Sondermuffen oder Adapter erforderlich (z.B. für gekrümmte Stützeisen)
- ✓ Montage trotz Winkelabweichung bis zu 3,5 ° leicht durchführbar

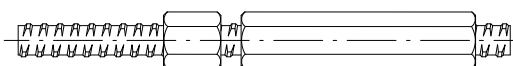

- ✓ Benutzerfreundlich integriert in den Konstruktions- und Bewehrungsprogrammen, wie

advantages compared to fine metric thread:

- ✓ robust thread can not be damaged
- ✓ selfcleaning effect
- ✓ cutting or extension possible at any position of the bar
- ✓ no need of expensive special couplers (e.g. for coupling bended bars)
- ✓ installation possible up to a bar inclination of 3,5°

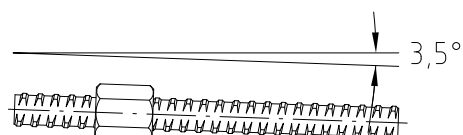

- ✓ user-optimized integration into the construction and reinforcing programs, as



Muffen - Stab - System

thread bar coupling system

Einsparung an Platz und Material
saving space and material



Verwendung der SAS Muffenverbindung anstatt eines Überlappungsstoßes.
Using SAS coupler connection instead of lap splices.

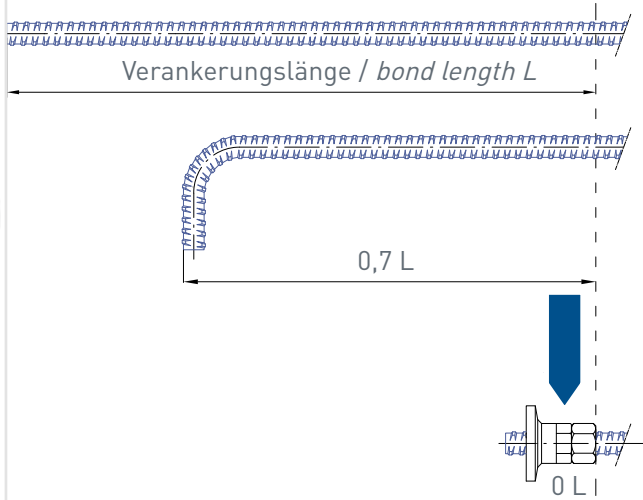

Verwendung der SAS Endverankerung anstatt eines geraden Verankerungsstabes oder Hakens.
Using SAS end anchorage instead of hook or long straight bar.

Muffenverbindung für gerade Anschlussstäbe

coupler connection for straight connecting bars

Halbmuffenstoß
coupling bar

Anschlussstab
connecting bar

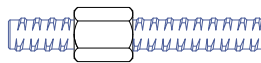
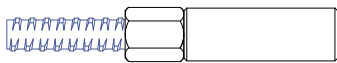

Sechskantmuffe für gebogene Anschlussstäbe

hexagonal coupler for bent connecting bars

Halbmuffenstoß
coupling bar

Anschlussstab
connecting bar

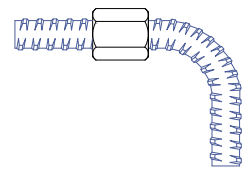
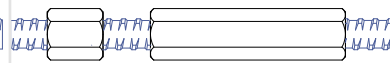

Sechskantmuffe für Verbindungen mit Aussparungskegel

connectin bar with hexagonal coupler & recess cone

Stab mit Aussparungskegel
thread bar with access cone

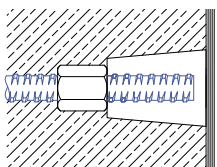

Schalung
formwork

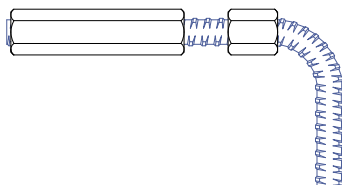

Anschlussstab mit Sechskantmuffe
connecting bar with hexagonal coupler

Endverankerung

end anchorage

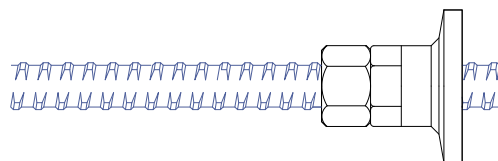

SAS Gewindestäbe

SAS thread bars

SAS 500 / 550 Ø 12 - 50 mm

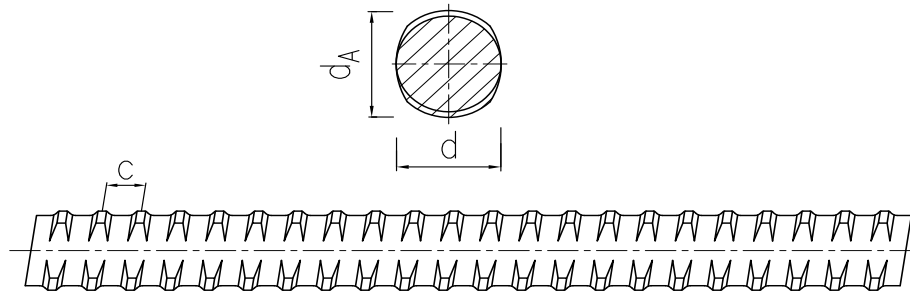

SAS Gewindestab

warmgewalzt, Rippenstahl - linksgängig

SAS thread bar

hot rolled, ribbed - left hand thread

SAS 500

d Ø	[mm]	12	14	16	20	25	28	32	36	40	43	50
max d _A	[mm]	14	16	19	23	29	32	36	41	45	48	56
c	[mm]	7	7,5	8	10	12,5	14	16	18	20	21	26
f _{yk} (f _{0,2k}) / f _{tk} / A _{gt} ¹⁾		500 N/mm ² / 550 N/mm ² / ≥ 6 %										
F _{yk} (F _{0,2k})	[kN]	57	77	100	160	245	310	405	510	630	726	980
F _{tk}	[kN]	62	85	110	175	270	340	440	560	690	799	1080
A	[mm ²]	113	154	201	314	491	616	804	1020	1260	1452	1960
G	[kg/m]	0,89	1,21	1,58	2,47	3,85	4,83	6,31	7,99	9,87	11,40	15,40

SAS 550

d Ø	[mm]	12	14	16	20	25	26	28	30	32	36	40	43	50	
max d _A	[mm]	14	16	19	23	29	30	32	34	36	41	45	48	56	
c	[mm]	7	7,5	8	10	12,5	13	14	15	16	18	20	21	26	
f _{yk} (f _{0,2k}) / A _{gt} ¹⁾		550 N/mm ² ≥ 6 %													
F _{yk} (F _{0,2k})	[kN]	62	85	110	175	270	290	340	390	440	560	690	799	1080	
F _{tk} = 1,08 x F _{yk}	[kN]	67	92	119	189	292	313	367	421	475	605	745	862	1166	
A	[mm ²]	113	154	201	314	491	531	616	707	804	1020	1260	1452	1960	
G	[kg/m]	0,89	1,21	1,58	2,47	3,85	4,17	4,83	5,55	6,31	7,99	9,87	11,40	15,40	

Zubehör | accessories

SAS SYSTEMS

Ankermutter
anchor nut

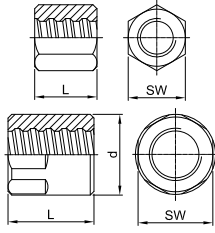

Ankermutter lang
anchor nut long

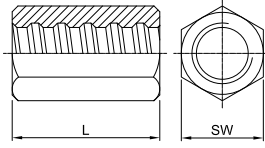

Ankermutter mit Bund
anchor nut with flange

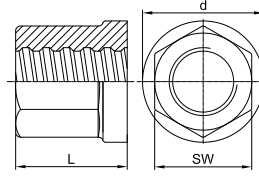

Ankerplatte gerade
anchor plate flat

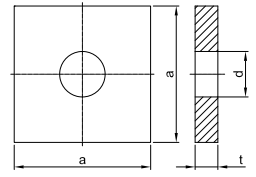

Ø [mm]	SW x L x d [mm]	[kg]	SW x L [mm]	[kg]	SW x L x d [mm]	[kg]	a x t x d [mm]	[kg]
	T 2002		T 2024		T 2163		T 2139	
12	22 x 25	0,05	22 x 35	0,08	-	-	50 x 8 x 16	0,14
14	27 x 35	0,15	27 x 45	0,17	-	-	50 x 8 x 18	0,14
16	32 x 40	0,20	32 x 50	0,25	-	-	60 x 8 x 20	0,21
20	36 x 45	0,26	32 x 65	0,26	-	-	70 x 12 x 25	0,42
25	41 x 50	0,34	41 x 75	0,51	-	-	90 x 15 x 30	0,87
26	46 x 50	0,45	41 x 80	0,48	-	-	100 x 15 x 33	1,08
28	46 x 55	0,48	41 x 85	0,44	-	-	100 x 15 x 33	1,08
30	50 x 60	0,65	46 x 90	0,77	-	-	120 x 20 x 36	2,10
32	55 x 60	0,78	50 x 90	0,86	-	-	120 x 20 x 40	2,06
36	60 x 65	1,00	55 x 95	1,17	-	-	150 x 30 x 44	4,94
40	65 x 70	1,19	60 x 100	1,27	65 x 70 x 85	1,42	150 x 30 x 47	4,89
43	70 x 75	1,51	-	-	70 x 80 x 90	1,81	160 x 40 x 50	7,42
50	80 x 90	2,17	80 x 120	3,00	80 x 85 x 100	2,48	190 x 45 x 58	11,82

SAS SYSTEMS

Ankerplatte gerade klein
anchor plate flat small

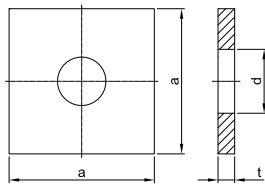

Kontermutter lang
lock nut long

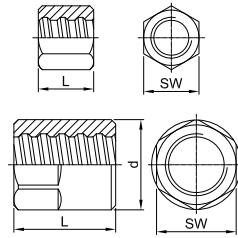

Kontermutter kurz
lock nut short

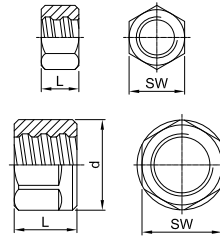

Ankerstück
anchor piece

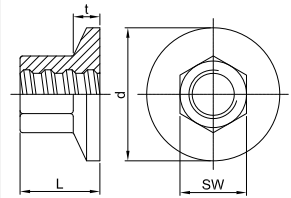

Ø [mm]	a x t x d [mm]	[kg]	SW x L x d [mm]	[kg]	SW x L x d [mm]	[kg]	SW x L x d [mm]	[kg]
	T 2008		T 2003		T 2040		T 2073	
12	-	-	19 x 20	0,03	19 x 13	0,03	-	-
14	-	-	27 x 25	0,08	27 x 15	0,06	-	-
16	-	-	32 x 30	0,15	32 x 20	0,10	30 x 33 x 50	0,25
20	-	-	32 x 40	0,16	32 x 20	0,08	36 x 40 x 65	0,43
25	-	-	41 x 40	0,25	41 x 20	0,14	41 x 45 x 70	0,50
26	-	-	41 x 45	0,26	41 x 25	0,15	41 x 50 x 90	0,70
28	-	-	41 x 45	0,26	41 x 25	0,15	46 x 50 x 90	0,77
30	-	-	50 x 50	0,52	50 x 30	0,28	50 x 55 x 95	1,00
32	-	-	50 x 50	0,47	50 x 30	0,28	50 x 60 x 100	1,40
36	-	-	55 x 55	0,61	55 x 30	0,37	60 x 65 x 110	1,75
40	120 x 17 x 47	1,69	60 x 65	0,83	60 x 35	0,45	65 x 70 x 120	1,85
43	-	-	70 x 65	1,31	70 x 40	0,80	70 x 80 x 130	2,43
50	150 x 20 x 58	3,12	80 x 80	1,94	80 x 50	1,21	80 x 85 x 150	3,75

SAS SYSTEMS

Kugelbundmutter 55°
domed nut 55°

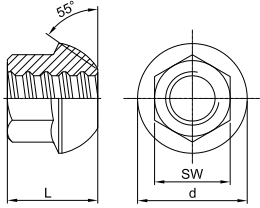

Ankerplatte Konus 55°
anchor plate cone 55°

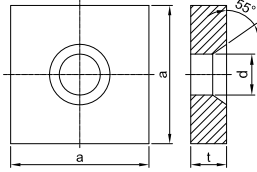

Kalottenmutter 30°
dome nut 30°

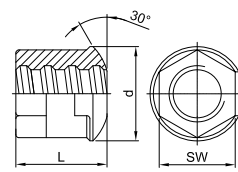

Ankerplatte ballig 30°/55°
domed washer 30°/55°

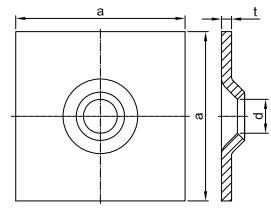

Ø [mm]

SW x L x d [mm]

[kg]

a x t x d [mm]

[kg]

SW x L x d [mm]

[kg]

a x t x d [mm]

[kg]

T 2044

T 2011

T 2944

T 2132

12	-	-	-	-	30 x 33 x 40	0,20	-	-
14	-	-	-	-	30 x 33 x 40	0,20	-	-
16	27 x 33 x 35	0,11	60 x 10 x 25	0,24	30 x 33 x 40	0,20	150 x 10 x 22	1,75
20	36 x 42 x 49	0,30	70 x 12 x 30	0,37	36 x 40 x 51	0,29	150 x 10 x 26	1,65
25	41 x 45 x 55	0,35	90 x 15 x 35	0,81	41 x 45 x 54	0,32	150 x 10 x 34	1,60
26	-	-	-	-	-	-	-	-
28	41 x 54 x 62	0,45	100 x 20 x 40	1,33	41 x 50 x 58	0,38	200 x 10 x 34	3,05
30	-	-	-	-	-	-	-	-
32	46 x 57 x 70	0,60	120 x 20 x 52	1,91	50 x 60 x 62	0,63	200 x 12 x 40	3,65
36	-	-	-	-	-	-	-	-
40	60 x 70 x 88	1,50	150 x 30 x 65	4,48	65 x 70 x 85	1,47	200 x 20 x 53	5,90
43	70 x 80 x 100	1,94	160 x 40 x 75	6,54	-	-	-	-
50	80 x 85 x 107	2,80	190 x 45 x 83	10,78	80 x 85 x 100	2,45	-	-

SAS SYSTEMS

Ankermutter ballig 30°
bull nose nut 30°

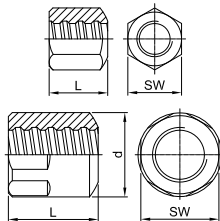

Ankerplatte Konus 30°
anchor plate cone 30°

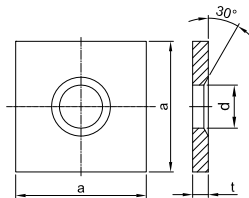

Ankerstück geschweißt
anchor piece welded

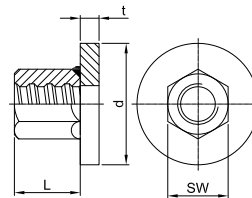

Ankerplatte Konus 30° groß
anchor plate cone 30° big

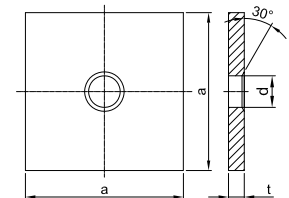

Ø [mm]

SW x L x d [mm]

[kg]

a x t x d [mm]

[kg]

SW x L x d x t [mm]

[kg]

a x t x d [mm]

[kg]

T 2963

T 1928

T 2973

T 2928

12	22 x 25	0,05	50 x 8 x 16	0,14	-	-	-	-
14	27 x 35	0,14	50 x 8 x 18	0,14	-	-	-	-
16	32 x 40	0,18	60 x 8 x 20	0,20	-	-	-	-
20	36 x 45	0,25	70 x 12 x 25	0,41	-	-	-	-
25	41 x 50	0,33	90 x 15 x 30	0,87	-	-	-	-
26	46 x 50	0,42	100 x 15 x 33	1,07	-	-	-	-
28	46 x 55	0,47	100 x 15 x 33	1,07	-	-	200 x 20 x 33	6,15
30	50 x 60	0,61	120 x 20 x 36	2,09	-	-	-	-
32	55 x 60	0,75	120 x 20 x 40	2,06	-	-	200 x 20 x 40	6,10
36	60 x 65	0,94	150 x 30 x 44	4,92	-	-	-	-
40	65 x 70	1,15	150 x 30 x 47	4,88	65 x 70 x 120 x 17	-	-	-
43	70 x 75	1,47	160 x 40 x 58	7,16	-	-	-	-
50	80 x 90	2,10	190 x 45 x 58	11,79	80 x 90 x 150 x 20	-	-	-

Zubehör | accessories

SAS SYSTEMS

Muffe standard
coupler standard

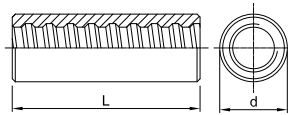

Gewindemuffe
thread coupler

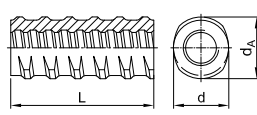

Kontaktmuffe
contact coupler

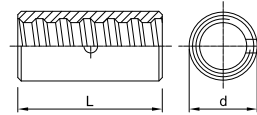

Sechskantmuffe lang
hexagonal coupler long

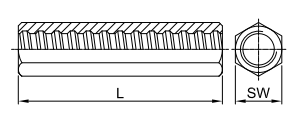

\emptyset [mm]	d x L [mm]	[kg]	d x d _A x L [mm]	[kg]	d x L [mm]	[kg]	SW x L [mm]	[kg]
	T 3003		T 3087		T 3006		T 3010	
12	22 x 60	0,11	-	-	-	-	22 x 80	0,17
14	27 x 75	0,22	-	-	-	-	27 x 100	0,34
16	32 x 90	0,37	26,5 x 31 x 90	0,27	-	-	32 x 120	0,59
20	36 x 105	0,52	32 x 37 x 105	0,40	32 x 70	0,22	32 x 140	0,54
25	40 x 115	0,61	40 x 46 x 115	0,68	36 x 80	0,30	41 x 160	1,08
26	45 x 120	0,91	47 x 53 x 120	1,13	36 x 80	0,26	41 x 170	1,08
28	45 x 125	0,85	47 x 53 x 125	1,09	40 x 85	0,34	41 x 180	1,02
30	50 x 135	1,19	47 x 53 x 135	1,10	45 x 90	0,46	50 x 180	1,71
32	52 x 140	1,32	57 x 64 x 140	1,92	45 x 90	0,46	50 x 180	1,71
36	60 x 150	1,92	57 x 64 x 150	1,78	50 x 120	0,73	60 x 180	2,75
40	65 x 160	2,34	65 x 72 x 160	2,52	54 x 120	0,82	65 x 210	3,58
43	80 x 170	4,49	75 x 82 x 170	3,79	60 x 130	1,19	70 x 220	4,46
50	80 x 200	4,49	-	-	63 x 160	1,09	80 x 240	6,12

SAS SYSTEMS

Muffe standard mit Mittelstopp
coupler standard with center stop

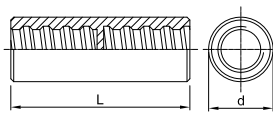

Gewindemuffe mit Mittelstopp
thread coupler with center stop

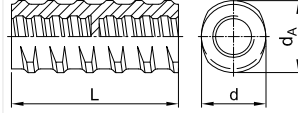

Reduziermuffe
reducing coupler

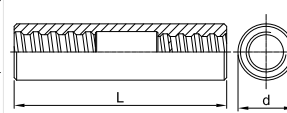

Spannschloss
tensioning lock

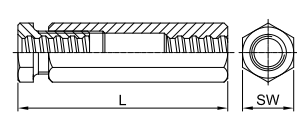

\emptyset [mm]	d x L [mm]	[kg]	d x d _A x L [mm]	[kg]	\emptyset x d x L [mm]	[kg]	SW x ~L [mm]	[kg]
	T 3002		T 3086		T 3102		T 3105	
12	22 x 60	0,12	-	-	-	-	32 x 130	0,62
14	27 x 75	0,23	-	-	-	-	32 x 140	0,69
16	32 x 90	0,38	26,5 x 31 x 90	0,28	16/14 x 32 x 120	0,55	36 x 150	0,92
20	36 x 105	0,54	32 x 37 x 105	0,42	20/16 x 36 x 130	0,67	41 x 175	1,12
25	40 x 115	0,65	40 x 46 x 115	0,71	25/20 x 40 x 150	1,00	46 x 190	1,42
26	45 x 120	0,83	47 x 53 x 120	1,16	26/20 x 40 x 155	1,10	50 x 205	1,83
28	45 x 125	0,89	47 x 53 x 125	1,12	28/25 x 45 x 170	1,24	50 x 205	1,78
30	50 x 135	1,23	47 x 53 x 135	1,14	30/28 x 50 x 180	1,62	60 x 225	2,92
32	52 x 140	1,37	57 x 64 x 140	1,98	32/28 x 52 x 180	1,80	60 x 225	2,87
36	-	-	-	-	36/32 x 60 x 205	2,61	70 x 250	5,20
40	-	-	-	-	40/32 x 65 x 210	3,29	80 x 270	6,60
43	-	-	-	-	43/40 x 80 x 225	5,93	90 x 290	12,21
50	-	-	-	-	50/43 x 80 x 250	5,68	100 x 310	16,87

SAS SYSTEMS

Muffe mit Drehsicherung
coupler with set screws

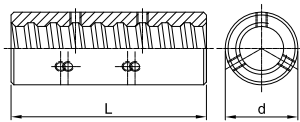

Muffe vergütet
coupler tempered

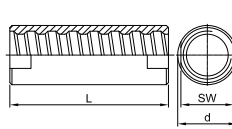

Anschweißstück
welding bolt

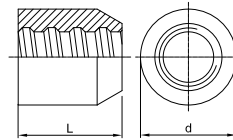

Anschweißstück SW
welding bolt hexagonal

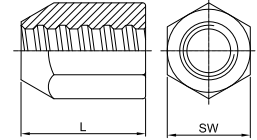

Ø [mm]	d x L [mm]	[kg]	SW x d x L [mm]	[kg]	d x L [mm]	[kg]	SW x L [mm]	[kg]
	T 3020		T 3927		T 3022		T 3026	
12	-	-	-	-	30 x 30	0,18	32 x 40	0,21
14	-	-	-	-	36 x 40	0,23	36 x 50	0,34
16	-	-	-	-	40 x 45	0,33	41 x 55	0,48
20	-	-	-	-	45 x 50	0,42	46 x 65	0,70
25	-	-	-	-	50 x 55	0,72	50 x 75	0,89
26	-	-	-	-	50 x 55	0,72	50 x 70	0,98
28	-	-	-	-	55 x 60	0,94	55 x 85	1,15
30	-	-	-	-	60 x 65	1,10	60 x 90	1,31
32	52 x 140	1,35	-	-	60 x 65	1,10	60 x 90	1,31
36	60 x 150	2,00	-	-	70 x 70	1,45	70 x 95	1,70
40	65 x 160	2,35	50 x 56 x 150	1,65	80 x 80	2,59	80 x 100	2,66
43	80 x 170	4,41	-	-	90 x 90	3,07	80 x 100	3,11
50	80 x 200	4,50	60 x 70 x 180	2,14	90 x 90	2,77	90 x 120	4,51

SAS SYSTEMS

Haltering
fix ring

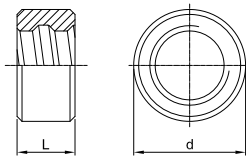

Verschlussstöpsel
inner cap

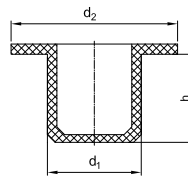

Aussparungskegel
recess cone

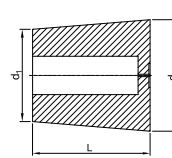

Nagelplatte
nail plate

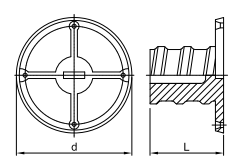

Ø [mm]	d x L [mm]	[kg]	d ₁ x d ₂ x h [mm]	[kg]	d ₁ x d ₂ x L [mm]	[kg]	d x L [mm]	[kg]
	T 5003		T 5025		T 5050		T 5979	
12	-	-	12 x 19 x 7	0,001	36 x 42 x 40	0,023	36 x 20	0,005
14	-	-	14 x 19 x 7	0,001	41 x 49 x 49	0,035	42 x 20	0,007
16	-	-	16 x 25 x 9	0,001	48 x 85 x 64	0,042	48 x 25	0,010
20	-	-	20 x 25 x 9	0,001	50 x 62 x 74	0,078	48 x 30	0,012
25	-	-	25 x 30 x 9	0,001	63 x 76 x 78	0,108	58 x 30	0,019
26	-	-	26 x 31 x 9	0,002	-	-	58 x 35	0,019
28	-	-	28 x 35 x 9	0,002	74 x 89 x 89	0,132	58 x 40	0,023
30	-	-	30 x 35 x 9	0,002	-	-	68 x 45	0,034
32	-	-	32 x 37 x 9	0,003	77 x 93 x 98	0,181	68 x 45	0,034
36	50 x 25	0,15	36 x 42 x 9	0,003	-	-	-	-
40	55 x 25	0,18	40 x 48 x 10	0,004	-	-	-	-
43	65 x 25	0,33	-	-	-	-	-	-
50	65 x 30	0,25	50 x 58 x 10	0,005	-	-	-	-

Zubehör | accessories

SAS SYSTEMS

Muffe angeschrägt
coupler chamfered

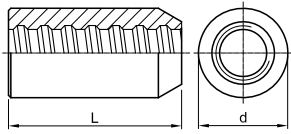

Ø [mm] d x L [mm] [kg]

Gabelstück
fork piece

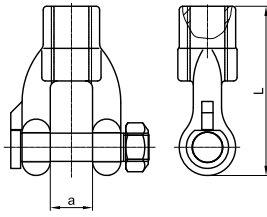

a x d x L [mm] [kg]

Spreizdübel
expansion shell

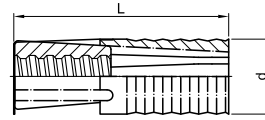

d x L [mm] [kg]

Ringmutter
ring nut

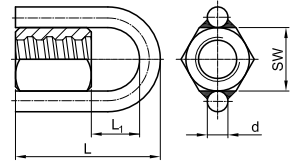

SW x L x L₁ x d [mm] [kg]

	T 3901		T 2926		T 2136		T 2927	
12	-	-	-	-	-	-	-	-
14	-	-	-	-	-	-	-	-
16	-	-	-	-	32 x 92	0,22	32 x 110 x 54 x 16	0,57
20	36 x 105	0,42	30 x 20 x 120	1,17	39 x 110	0,45	36 x 120 x 59 x 16	0,67
25	40 x 115	0,50	30 x 20 x 120	1,10	49 x 120	0,63	41 x 130 x 64 x 16	0,77
26	-	-	-	-	-	-	-	-
28	45 x 125	0,74	-	-	49 x 120	0,57	46 x 145 x 74 x 16	0,97
30	-	-	-	-	-	-	-	-
32	52 x 140	1,22	-	-	59 x 150	1,02	55 x 165 x 89 x 16	1,34
36	-	-	-	-	-	-	-	-
40	-	-	-	-	-	-	65 x 194 x 103 x 20	2,10
43	-	-	-	-	-	-	-	-
50	-	-	-	-	-	-	79 x 234 x 122 x 20	3,29

SAS SYSTEMS

Ankermutter EP gerade
anchor nut EP flat

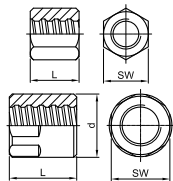

Ø [mm] SW x L x d [mm] [kg]

Ankermutter EP lang
anchor nut EP long

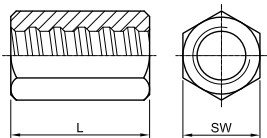

SW x L [mm] [kg]

Ankermutter EP ballig 30°
bull nose nut EP 30°

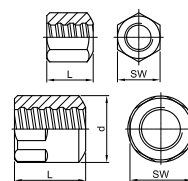

SW x L x d [mm] [kg]

Kontermutter EP lang
lock nut EP long

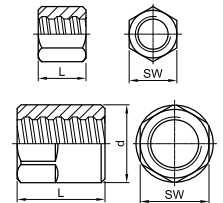

SW x L x d [mm] [kg]

	T 2002 EP		T 2024 EP		T 2963 EP		T 2003 EP	
12	22 x 30	0,07	22 x 35	0,08	-	-	19 x 25	0,05
14	27 x 40	0,14	27 x 45	0,17	-	-	27 x 30	0,12
16	32 x 50	0,25	32 x 50	0,25	32 x 50	0,21	32 x 35	0,17
20	36 x 55	0,31	32 x 65	0,26	36 x 55	0,28	32 x 45	0,18
25	41 x 60	0,40	41 x 75	0,44	41 x 60	0,40	41 x 50	0,31
26	46 x 60	0,60	41 x 80	0,48	-	-	41 x 55	0,38
28	46 x 65	0,55	41 x 85	0,51	46 x 65	0,46	41 x 55	0,31
30	50 x 75	0,84	46 x 90	0,77	-	-	50 x 60	0,67
32	55 x 75	0,97	50 x 90	0,86	55 x 75	0,93	50 x 60	0,57
36	60 x 80	1,28	55 x 95	1,17	-	-	55 x 65	0,77
40	65 x 85	1,43	60 x 100	1,27	65 x 85	1,40	60 x 75	0,96
43	70 x 90	1,81	-	-	70 x 90	1,77	70 x 75	1,51
50	80 x 105	2,45	80 x 120	2,92	80 x 105	2,41	80 x 95	2,50

Kontermutter EP kurz
lock nut EP short

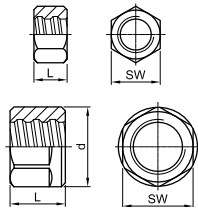

Muffe EP standard
coupler EP standard

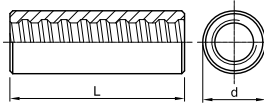

Kontaktmuffe EP
contact coupler EP

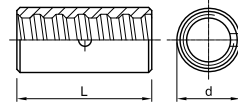

Sechskantmuffe EP lang
hexagonal coupler EP long

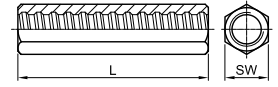

Ø [mm]	SW x L [mm]	[kg]	d x L [mm]	[kg]	d x L [mm]	[kg]	SW x L [mm]	[kg]
	T 2040 EP		T 3003 EP		T 3006 EP		T 3010 EP	
12	19 x 20	0,03	22 x 75	0,15	-	-	22 x 80	0,16
14	27 x 25	0,09	27 x 90	0,27	-	-	27 x 100	0,33
16	32 x 30	0,15	32 x 105	0,46	-	-	32 x 120	0,54
20	32 x 40	0,17	36 x 120	0,59	32 x 70	0,22	32 x 140	0,59
25	41 x 40	0,28	40 x 135	0,71	36 x 80	0,30	41 x 160	1,07
26	41 x 45	0,31	45 x 140	1,13	36 x 80	0,27	41 x 170	1,01
28	41 x 45	0,41	45 x 145	0,97	40 x 85	0,34	41 x 180	1,10
30	50 x 50	0,54	50 x 155	1,50	45 x 90	0,50	50 x 180	1,75
32	50 x 50	0,50	52 x 160	1,49	45 x 90	0,45	50 x 180	1,71
36	55 x 55	0,64	60 x 170	2,30	50 x 120	0,72	60 x 190	2,75
40	60 x 65	0,85	65 x 190	3,07	54 x 120	0,82	65 x 210	2,71
43	70 x 65	-	80 x 200	5,28	60 x 130	1,18	-	-
50	80 x 80	2,10	80 x 235	5,50	65 x 160	1,11	80 x 240	5,88

Zulassungen | approvals



Unsere aktuellen Zulassungen können Sie jederzeit direkt aus dem Downloadbereich unserer Homepage herunterladen.

www.annahuette.com

Darüber hinaus verfügen auch unsere Partner-Unternehmen in weiteren Ländern über zusätzliche Zulassungen und Zertifikate für die verschiedensten Anwendungen.

Current approvals and certificates can be downloaded from our homepage.

www.annahuette.com

Furthermore, the partner-companies of SAH own further approvals and certificates in several countries for different applications as well.

Muffenverbindung

coupler connection

Anschlussstab ist längs verschiebbar und frei drehbar.
Connecting bar is lengthwise moveable and rotatable.

T 3003	T 2003 (T 2040)
Muffe standard	Kontermutter
<i>coupler standard</i>	<i>lock nut</i>

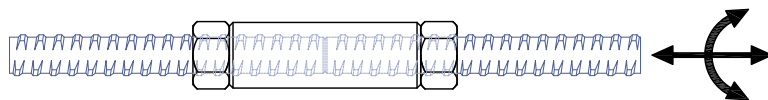

Anschlussstab ist längs verschiebbar und nicht frei drehbar
Connecting bar is lengthwise moveable and not rotatable

T 3010	T 2003 (T 2040)
Sechskantmuffe	Kontermutter
<i>hexagonal coupler</i>	<i>lock nut</i>

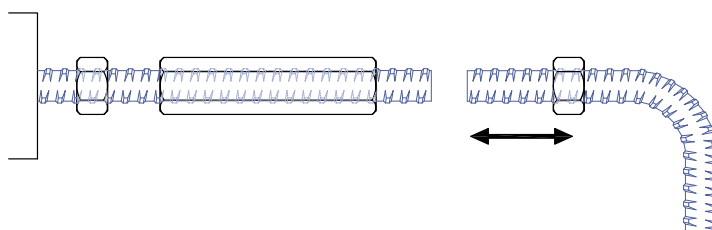

Anschlussstab ist weder längs verschiebbar noch frei drehbar
Connecting bar is neither moveable nor rotatable

T 3105	T 2003 (T2040)
Spannschloss	Kontermutter
<i>turnbuckle</i>	<i>lock nut</i>

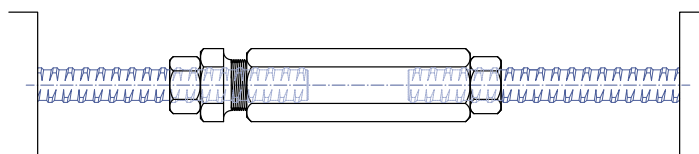

Verbindung unterschiedlicher Stabdurchmesser
Connecting of different bar diameters

T 3102	T 2003 (T2040)
Reduziermuffe	Kontermutter
<i>reducing coupler</i>	<i>lock nut</i>

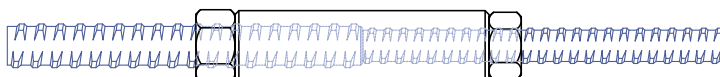

Verbindung von Druckstäben
Connecting of compression bars

T 3006
Kontaktmuffe
<i>contact coupler</i>

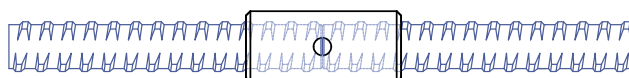

Endverankerung

end anchorage

Endverankerung unter Zuglast

End anchorage under tensile load

T 2073
Ankerstück
anchor piece

T 2040
Kontermutter kurz
lock nut

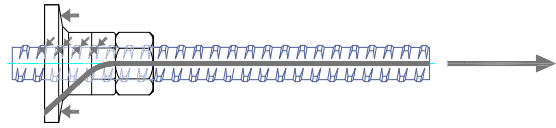

T 2002
Ankermutter
anchor nut

T 2139
Ankerplatte
anchor plate

T 2040
Kontermutter kurz
lock nut short

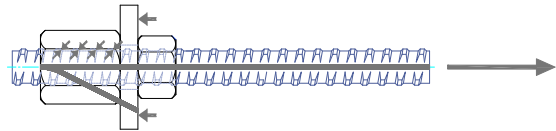

Endverankerung unter Drucklast

end anchorage under compression load

T 2040
Kontermutter kurz
lock nut short

T 2073
Ankerstück
anchor piece

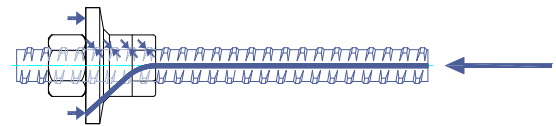

T 2040
Kontermutter kurz
lock nut short

T 2139
Ankerplatte
anchor plate

T 2002
Ankermutter
anchor nut

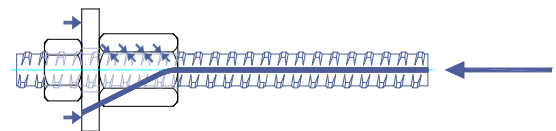

Endverankerung unter Wechsellast

end anchorage under alternating load

T 2002
Ankermutter
anchor nut

T 2073
Ankerstück
anchor piece

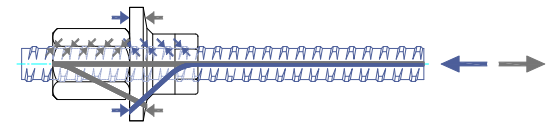

T 2002
Ankermutter
anchor nut

T 2139
Ankerplatte
anchor plate

T 2002
Ankermutter
anchor nut

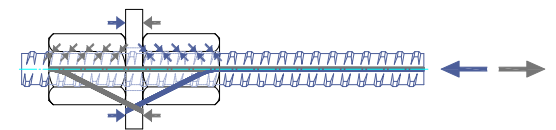

Abhängung (Stab ist nicht fixiert)

suspension (thread bar is not fixed)

T 2002
Ankermutter
anchor nut

T 2003
Kontermutter lang
lock nut long

T 2139
Ankerplatte gerade
anchor plate flat

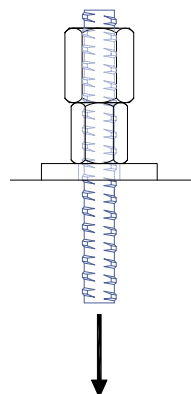

Aufgesetzte Endverankerung (Stab ist fixiert)

external end anchorage (thread bar is fixed)

T 2040
Kontermutter kurz
lock nut short

T 2002
Ankermutter
anchor nut

T 2139
Ankerplatte gerade
anchor plate flat

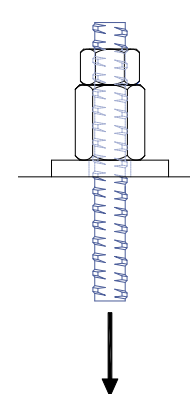

gerader Stab / *straight bar*

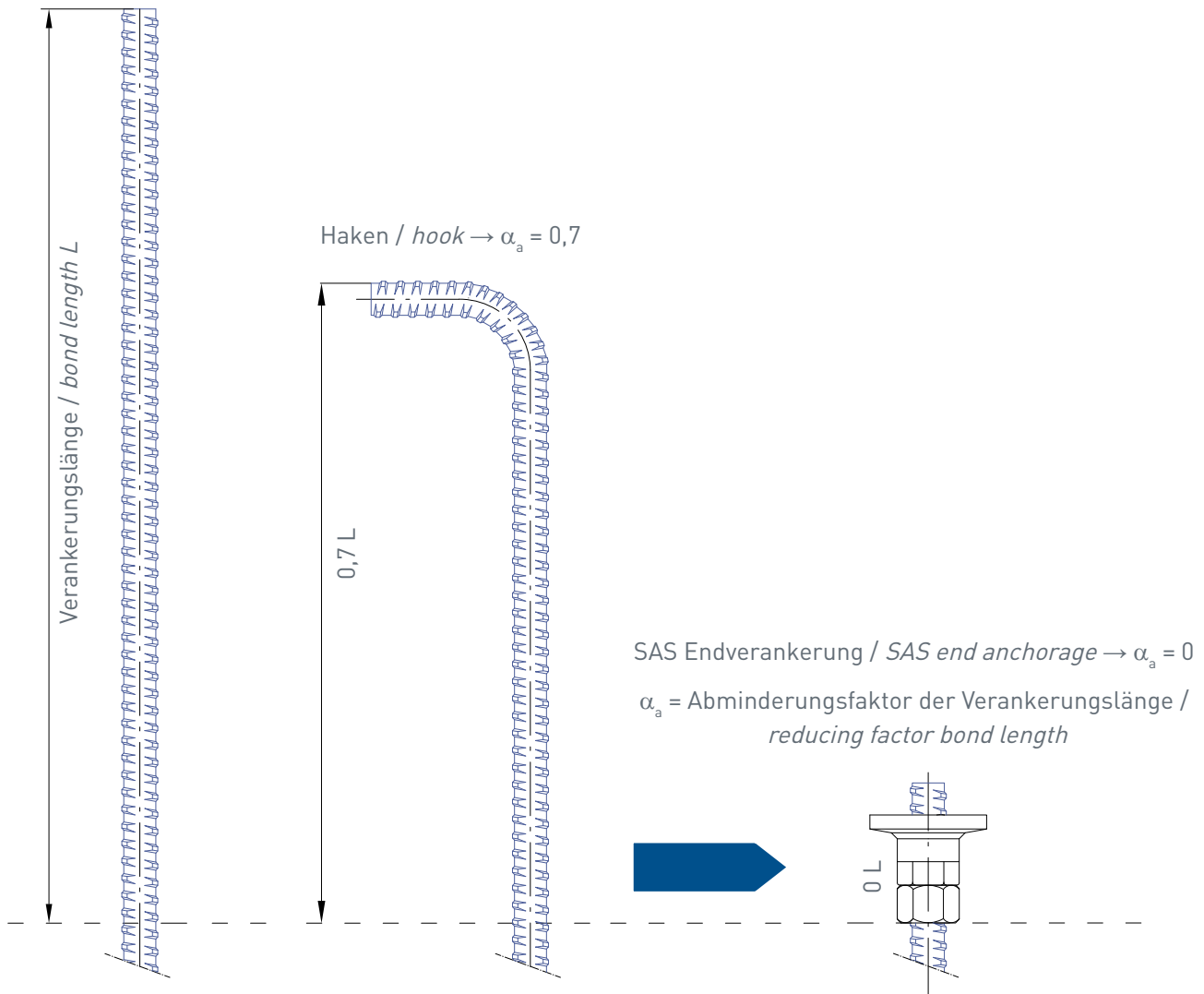

Bei Verwendung der SAS Endverankerung ist keine Verankerungslänge notwendig ($\alpha_a = 0$), wenn die Zusatzbewehrung nach Zulassung eingehalten wird. Die Lastabtragung erfolgt über die Flächenpressung der Ankerplatte bzw. des Ankerstückes.

By using SAS end anchorage no bond length is necessary ($\alpha_a = 0$), if the additional reinforcing according approval is used. The load will be transferred due to the contact pressure of anchor plate or anchor piece.

Kraftverlauf - Muffenstoß

load transfer - coupler connection

Zuglast tension load

T 2040
Verwendung der Kontermutter, kurz

using lock nut, short

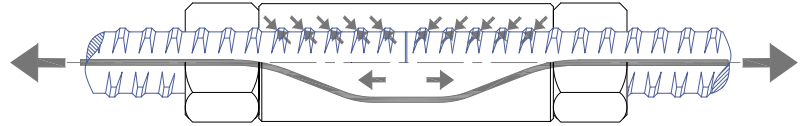

Drucklast compression load

T 2003
Verwendung der Kontermutter, lang

using lock nut, long

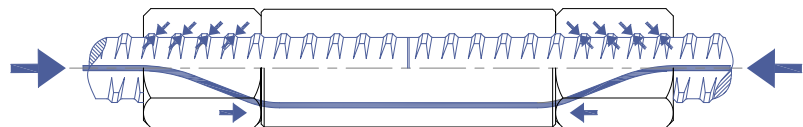

Wechsellast alternating load

T 2003
Verwendung der Kontermutter, lang

using lock nut, long

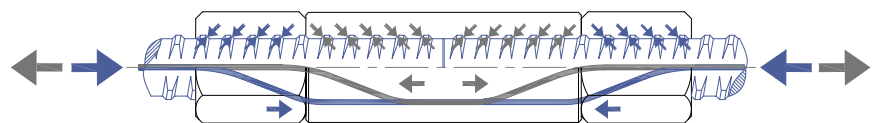

Drucklast compression load

T 3006
Verwendung der Kontaktmuffe

using contact coupler

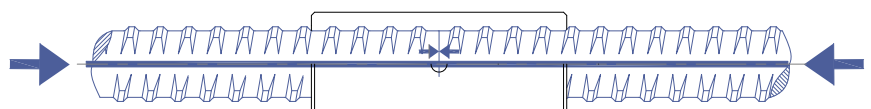

Planungsunterlagen

design documents

Halbmuffenstoß <i>coupling bar</i>	Typ HMS <i>type HMS</i>	Anschlussstab <i>connecting bar</i>	Typ AS <i>type AS</i>
----------------------------------------------	-----------------------------------	-----------------------------------------------	---------------------------------

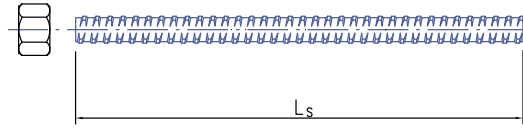
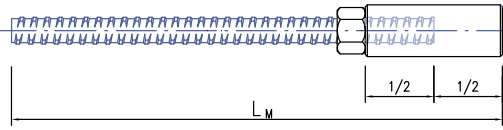

Halbmuffenstab, gebogen <i>hook extension bar</i>	Typ HMSG <i>type HMSG</i>	Anschlussstab <i>connecting bar</i>	Typ AS <i>type AS</i>
-------------------------------------------------------------	-------------------------------------	-----------------------------------------------	---------------------------------

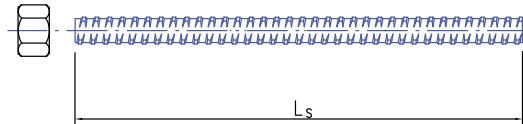
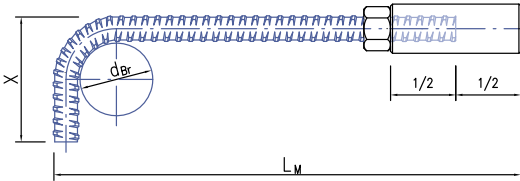

Doppelmuffenstab <i>fitting bar</i>	Typ DMS <i>type DMS</i>	Anschlussstäbe (2 Stück) <i>connecting bars (2 pieces)</i>	Typ AS <i>type AS</i>
-----------------------------------------------	-----------------------------------	----------------------------------------------------------------------	---------------------------------

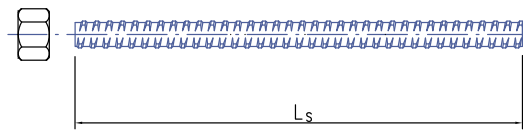
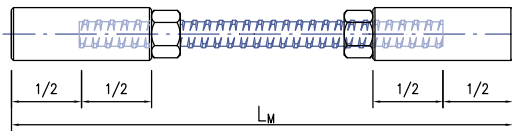

Halbmuffenstab, Schlaufe <i>loop bar</i>	Typ HMSS <i>type HMSS</i>	Anschlussstäbe (2 Stück) <i>connecting bars (2 pieces)</i>	Typ AS <i>type AS</i>
----------------------------------------------------	-------------------------------------	----------------------------------------------------------------------	---------------------------------

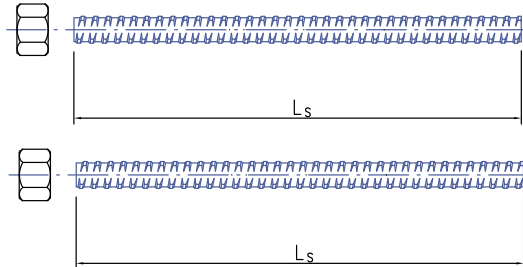
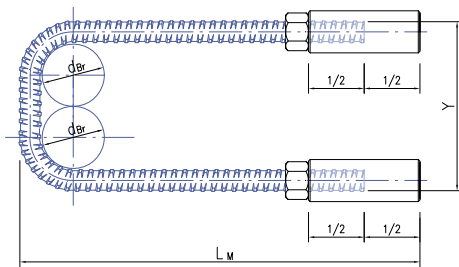

Endverankerungsstab <i>end anchorage bar</i>	Typ EVS <i>type EVS</i>	Endverankerung vorgekontert <i>end anchorage bar torqued</i>	Typ EVV <i>type EVV</i>
--------------------------------------------------------	-----------------------------------	------------------------------------------------------------------------	-----------------------------------

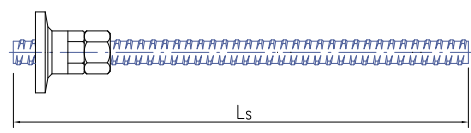
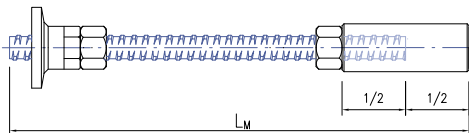

Legende

legend

- L_M = Länge Muffenstab inkl. 1/2 Muffenlänge / length of coupling bar incl. 1/2 coupler length
- L_S = Länge Stab / length of connectig bar
- X = Schenkellänge / side length
- Y = Außenmaß bei Schlaufen / overall dimension of loop
- d_{Br} = Biegerollendurchmesser / bending roll diameter
- alle Maße sind Außenmaße / all dimensions are overall dimensions

Stützenverjüngung
tapered column

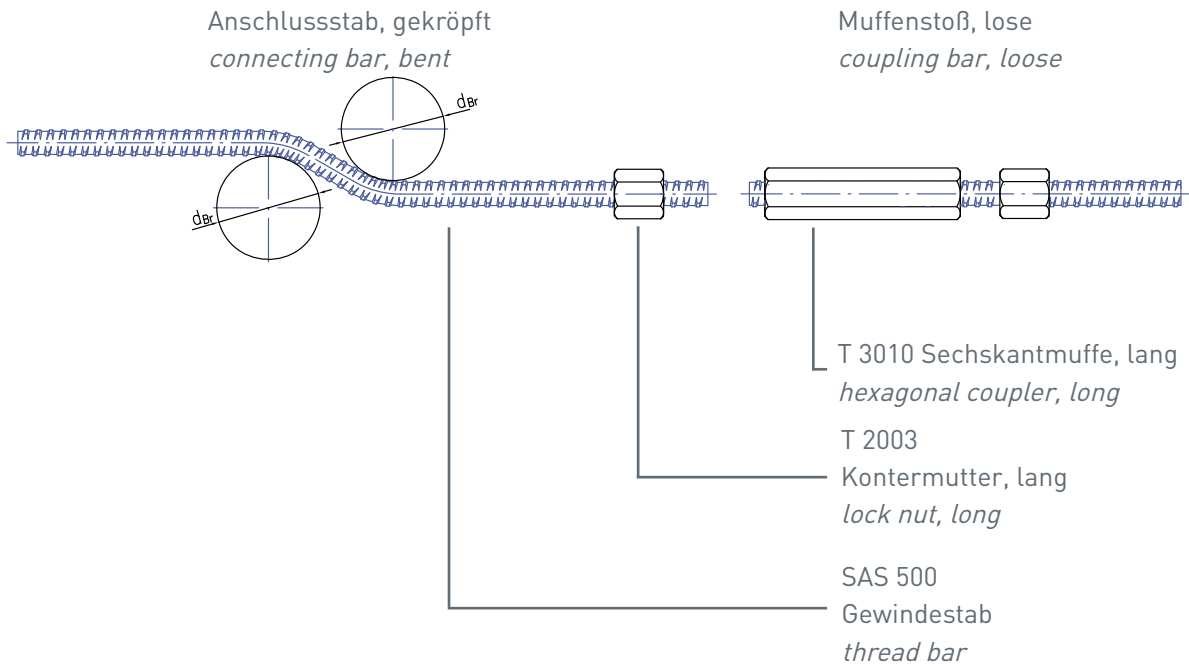

Anschluss: Unterzüge, Decken, Rahmenecken
connection: beam, roof, frame corner

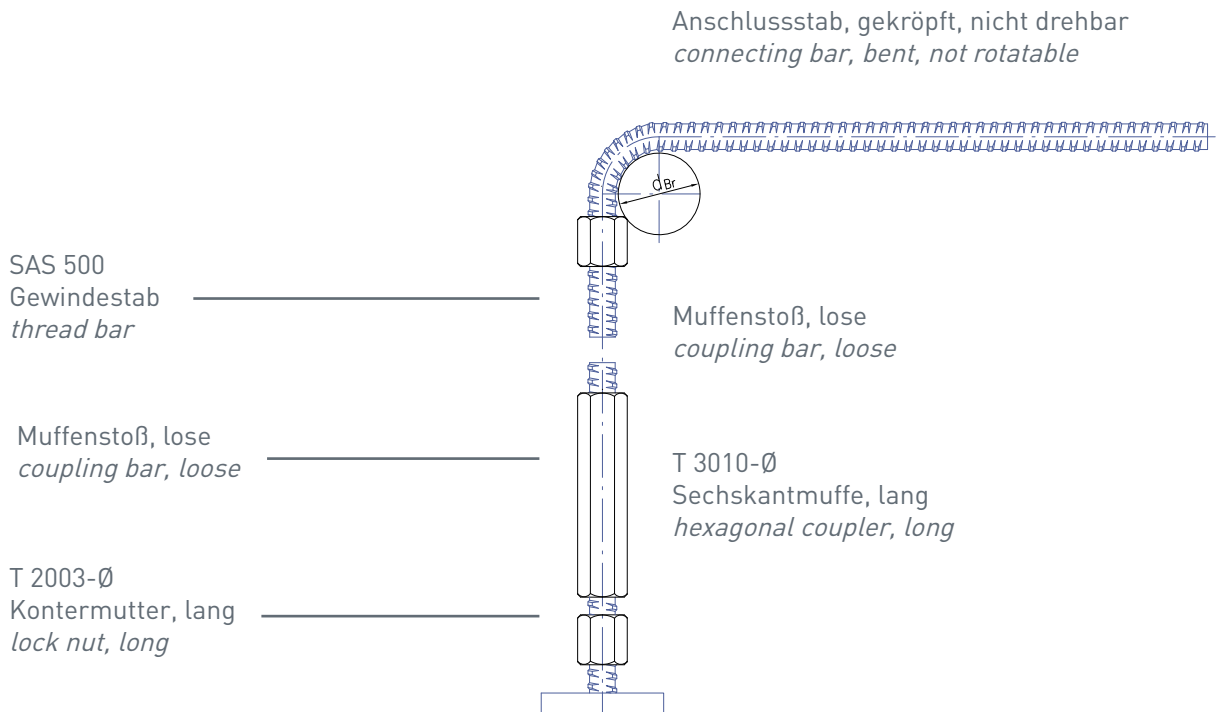

Einfach und günstig - ohne Positionsmuffe!
Simple and low cost - without position coupler!

Planungsunterlagen

design documents

Mindestabmessungen beim Biegen

Minimum dimensions for bending

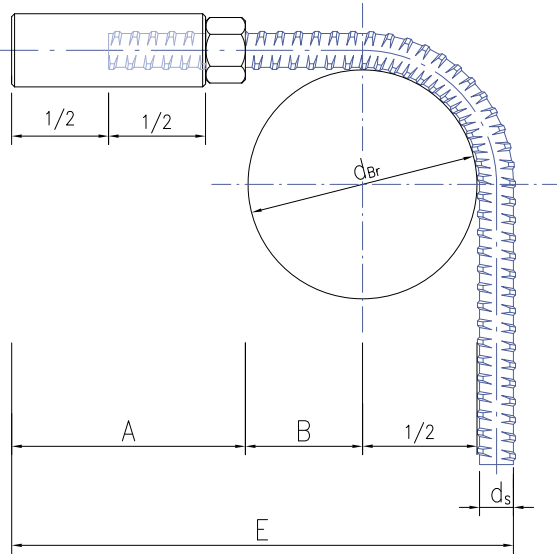

Legende:

legend:

- d_s = Stabdurchmesser *thread bar diameter*
- d_{Br} = Biegerolldurchmesser *bending roll diameter*
- A = Länge Muffenstoß *length of coupler joint*
- B = $2 \times d_s$ *$2 \times d_s$*
- E = min. Einbaulänge (Außenmaß) *min. total length (overall measure)*

$$E = A + B + d_{Br} / 2 + d_s \text{ [mm]}$$

\emptyset [mm]	A [mm]	B [mm]	$d_{Br} = 4 \times d_s$	$d_{Br} = 7 \times d_s$	$d_{Br} = 10 \times d_s$	$d_{Br} = 15 \times d_s$	$d_{Br} = 20 \times d_s$
12	80	24	140	158	176	206	236
14	90	28	160	181	202	237	272
16	110	32	185	209	233	273	315
20	125	40	-	255	285	335	385
25	135	50	-	397,5	335	397,5	460
28	150	56	-	332	374	444	514
32	170	64	-	378	426	506	586

Kontermomente

torque moments

\emptyset [mm]	12	14	16	20	25	26	30	28	32	36	40	43	50
Drehmoment ¹⁾ torque moment [kNm]	0,08	0,15	0,20	0,40	0,70	0,80	1,20	0,95	1,60	2,70	2,90	5,00	8,00
Konterart kind of torquing	manuell mit Drehmomentschlüssel hand operated torque wrench								hydraulisch Kontern mit Kontergerät hydraulic torque wrench				

¹⁾ Standardwert (weitere Werte entnehmen Sie bitte den entsprechenden Zulassungen)

¹⁾ standard value (for further values please check the approvals)

Zur Schlupfminderung sind SAS Muffenverbindungen und Endverankerungen mit definierten Kontermomenten zu kontern.

For reducing slip the SAS coupler connections and end anchorages are to torque with a defined torque moment.

Stababstände

bar distances

Mindestabstand für Muffenstöße
 minimal bar distance for coupler connection

ohne Längenversatz
 without length offset

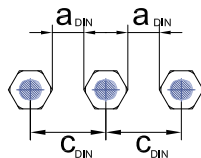

mit Längenversatz
 with length offset

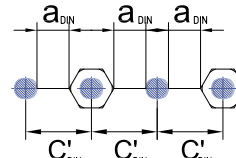

Mindestabstand für Muffenstöße
 minimal bar distance for coupler connection

ohne Längenversatz
 without length offset

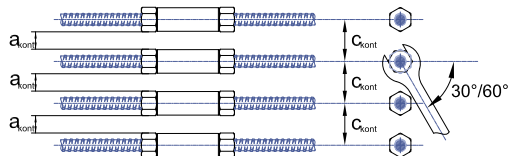

mit Längenversatz
 with length offset

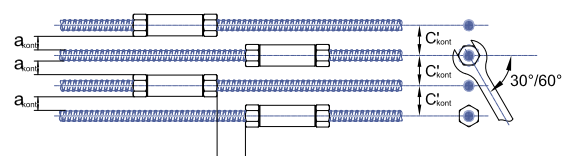

Erforderlicher Achsabstand c_{kont} für das Kontern ohne Längenversatz
 required distance c_{kont} for torquing without length offset

Erforderlicher Achsabstand c'_{kont} für das Kontern mit Längenversatz
 required distance c'_{kont} for torquing with length offset

Achsabstände für Muffenstöße [mm] / centre distance for coupler connection [mm]
 für Stabdurchmesser / for bar diameter

\emptyset [mm]		12	14	16	20	25	28	32	40	50
Erforderlicher Achsabstand required centre distance	C_{DIN}	42	47	52	56	65	73	84	105	130
	C'_{DIN}	37	41	44	48	58	65	74	93	115
Erforderlicher Achsabstand für das Kontern (30°) required centre distance for torquing (30°)	C_{30°	55	55	55	55	70	70	90	100	130
	C'_{30°	50	50	50	50	60	60	80	90	115
Erforderlicher Achsabstand für das Kontern (60°) required centre distance for torquing (60°)	C_{60°	90	90	90	90	110	120	130	130	160
	C'_{60°	85	85	85	85	100	110	120	120	145

SAS Kelebesystem MABOND

SAS Glue System MABOND



Bestandteile / components

- Kleberkartusche Mabond / glue cartridge Mabond
- Mischwendel / satic mixer
- Auspresspistole / coaxial gun

Geklebte Verbindung mit Standardmuffe T 3003 oder Gewindemuffe T3087

Glued connection with standard coupler T3003 or Thread bar coupler T3087

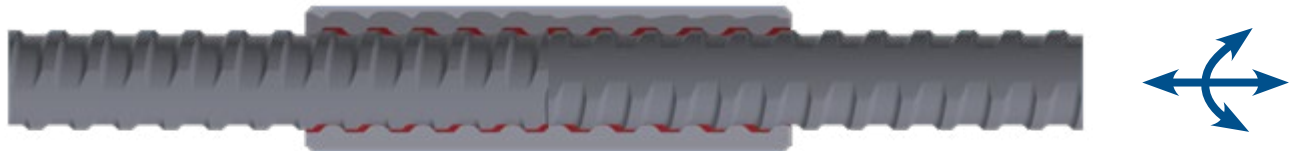

Anschlussstab ist drehbar und längs verschiebbar
connecting bar is lengthwise moveable and rotatable

Geklebter Halbmuffenstoß mit Standardmuffe (Mittelstopp) T3002 oder T3086

Glued pre-assembled connection with standard coupler (middlestop) T3002 or T3086

Die vorgefertigten Halbmuffenstäbe sind auch geklebt erhältlich
pre-assembled coupling bars also available as glued connection

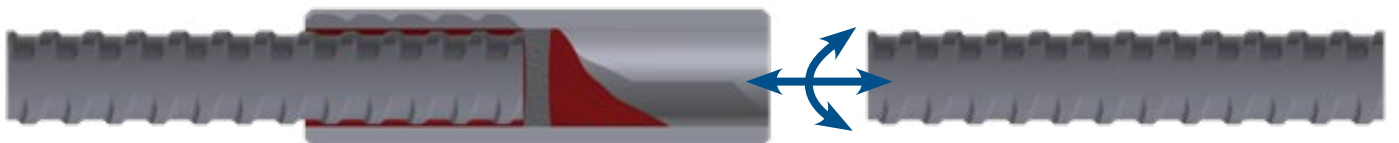

Anschlussstoß ist drehbar und längs verschiebbar
connecting bar is lengthwise moveable and rotatable

Kontermomente für geklebte Muffenverbindungen
Torque moments for glued coupler connection

Ø [mm]	12	14	16	20	25	26	30	28	32	36	40	43	50
<i>Drehmoment torque moment</i> [kNm]	0,08	0,15	0,20	0,40	0,60	0,60	0,60	0,60	0,70	0,80	0,80	1,00	1,00

Gebrauchshinweise: Klebermenge
Directions for use: amount of glue

Stab - Ø bar - Ø	Standardmuffenstoß <i>Coupler connection T3003 oder T3087</i>		Halbmuffenstoß <i>pre coupled connection T3002 oder T3086</i>	
	Klebermenge <i>Amount of glue</i>	Pumpenhöhe <i>Strokes of pump</i>	Klebermenge <i>Amount of glue</i>	Pumpenhöhe <i>Strokes of pump</i>
[mm]	[ml]	[-]	[ml]	[-]
12	3,2	0,5	1,6	0,3
14	4,8	0,8	2,4	0,4
16	6,5	1,0	3,3	0,5
20	11,3	1,8	5,7	0,9
25	13,0	2,0	6,5	1,0
26	14,6	2,3	7,3	1,1
28	16,3	2,5	8,1	1,3
30	19,5	3,0	9,8	1,5
32	22,8	3,5	11,4	1,8
36	29,3	4,5	-	-
40	35,8	5,5	-	-
43	45,5	7,0	-	-
50	65,0	10,0	-	-

Gebrauchshinweise: Verarbeitungszeit
Directions for use: processing time













Temperatur <i>Temperature</i>	Verarbeitungszeit <i>Processing time</i>	Minimale Aushärtezeit <i>min. curing time</i>
[°C]	[min]	
+40	1.4	15 min
+35 to +39	1.4	20 min
+30 to +34	2	25 min
+20 to +29	4	45 min
+10 to +19	6	1:20 h
+5 to +9	12	2:00 h
0 to +4	20	3:00 h
-4 to -1	45	5:30 h
-5	90	5:30 h

Bei feuchter Muffenverbindung muss die minimale Aushärtungszeit verdoppelt werden.
In wet coupler connections the minimal curing time has to be doubled.



Projekt: Opernturm Frankfurt
project: *Frankfurt opera tower*



Streckgrenze / Zugfestigkeit yield stress / ultimate stress Anwendungsbereiche / areas of application		Nenn- \varnothing nom.- \varnothing	Strecklast yield load	Bruchlast ultimate load	Fläche cross section area	Gewicht weight	Dehnung elongation				
		[mm]	[kN]	[kN]	[mm ²]	[m/to]	[kg/m]	A _{gt} [%]	A ₁₀ [%]		
SAS 500 / 550 - grade 75											
 Bewehrungstechnik / reinforcing systems		12	57	62	113	1123,6	0,89	6	10		
		14	77	85	154	826,4	1,21				
		16	100	110	201	632,9	1,58				
		20	160	175	314	404,9	2,47				
		25	245	270	491	259,7	3,85				
 Geotechnik / geotechnical systems		28	310	340	616	207,0	4,83				
		32	405	440	804	158,5	6,31				
		36	510	560	1020	125,2	7,99				
		40	630	690	1260	101,3	9,87				
		43	726	799	1452	87,7	11,40				
	50	980	1080	1960	64,9	15,40					
SAS 555 / 700 - grade 80		57,5	1441	1818	2597	49,1	20,38	5	10		
SAS 555 / 700 - grade 80		63,5	1760	2215	3167	40,2	24,86	5	---		
SAS 500 / 550 - grade 75		75	2209	2430	4418	28,8	34,68	5	---		
<i>Alternativ SAS 550 erhältlich / alternative SAS 550 grade 75 available</i>											
SAS 450 / 700 - grade 60											
 Bergbau / mining		16	93	145	207	617,3	1,62		(A ₅) 15		
		25	220	345	491	259,7	3,85		(A ₅) 20		
SAS 650 / 800 - grade 90											
 Bergbau / mining		22	247	304	380	335,6	2,98	5	(A ₅) 18		
		25	319	393	491	259,7	3,85				
		28	400	493	616	207,0	4,83				
		30	460	565	707	180,2	5,55				
SAS 670 / 800 - grade 97											
 Geotechnik / geotechnical systems		18	170	204	254	500,0	2,00			5	10
		22	255	304	380	335,6	2,98				
		25	329	393	491	259,7	3,85				
		28	413	493	616	207,0	4,83				
 Ankertechnik / tunneling & mining		30	474	565	707	180,2	5,55				
		35	645	770	962	132,5	7,55				
		43	973	1162	1452	87,7	11,40				
		50	1315	1570	1963	64,9	15,40				
 Hochfeste Bewehrung / high-strength reinforcement		57,5	1740	2077	2597	49,1	20,38		---		
		63,5	2122	2534	3167	40,2	24,86		---		
		75	2960	3535	4418	28,8	34,68		---		
	SAS 950 / 1050 - grade 150										
 Spanntechnik / post-tensioning systems		18	230	255	241	510,2	1,96	5	7		
		26,5	525	580	551	223,2	4,48				
		32	760	845	804	153,1	6,53				
		36	960	1070	1020	120,9	8,27				
 Geotechnik / geotechnical systems		40	1190	1320	1257	97,9	10,21				
		47	1650	1820	1735	70,9	14,10				
	SAS 835 / 1035 - grade 150										
 Geotechnik / geotechnical systems		57	2155	2671	2581	47,7	20,95			4	---
		65	2780	3447	3331	36,9	27,10				---
		75	3690	4572	4418	27,9	35,90				---
SAS 900 / 1100 FA - grade 160 FA schweißbar / weldable											
 Schalungstechnik / formwork ties		15	159	195	177	694,4	1,44	3	7		
		20	283	345	314	390,6	2,56				
		26,5	495	606	551	223,2	4,48			2	
SAS 900 / 1050 FC - grade 150 FC											
 Schalungstechnik / formwork ties		15	159	186	177	694,4	1,44	3	7		
		20	283	330	314	390,6	2,56				
SAS 950 / 1050 E - grade 150		26,5	525	580	551	223,2	4,48	5	7		
SAS 750 / 875 FS - kaltgerollt / cold rolled - grade 120 FS schweißbar / weldable											
 Schalungstechnik / formwork ties		12,5	90	120	132,5	961,5	1,04	2	5,5		
		15	142	165	189	675,7	1,48				
		20	245	285	326	390,6	2,56				

Zubehör für alle Abmessungen und Anwendungen lieferbar / accessories for all dimensions and applications available

Stahlwerk Annahütte
 Max Aicher GmbH & Co. KG
 Max Aicher Allee 1+2 • 83404 Hammerau • Deutschland
 Tel. +49 (0) 8654 487 0 • Fax +49 (0) 8654 487 968
 stahlwerk@annahuette.com • www.annahuette.com